



**ALSTOM STANDARD FOR RAILWAY APPLICATIONS
ASSEMBLIES AND PARTS CRITICALITY MANAGEMENT**

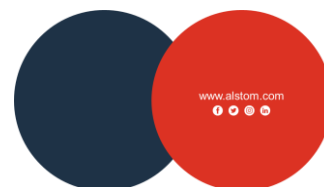
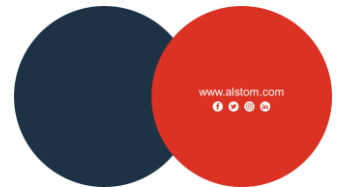

TABLE OF MODIFICATIONS

Revision	Publication	Summary of Changes
F	24/06/2022	Focus on H, M, L safety level and Safety logo. Safety level declassification proposal Second effort path clarification Electrical cubicles considered Exported constraints clarified
E1	31/10/2018	Global review prior to publication
E	01/06/2018	Removal of classification list and adding of decision trees – Global update for consistency purpose
D	10/02/2011	Definition of safety assembly and update of items classification
C	10/02/2009	EN 15085 / Items classification
B	07/09/2006	Items classification
A	10/02/2005	Creation



CONTENTS

1. Purpose.....	5
2. Normative references.....	6
2.1. Standard references.....	6
2.2. ALSTOM Standard references.....	6
3. Terms and definition.....	7
3.1. Safety level.....	7
3.2. SRIL.....	7
3.3. Safety logo.....	7
3.4. Redundancy and fall arrester.....	8
3.5. Stacked assemblies.....	8
4. PROCESS Overview.....	9
5. design concepts and safety levels Identification for fall of parts or collision hazards.....	11
5.1. Car body shell.....	11
5.2. Electrical cubicle frame.....	11
5.3. Equipment.....	12
5.4. Cabling and piping.....	12
6. Project DELIVERABLES.....	13
6.1. Design deliverables.....	13
6.2. Engineering justification file.....	14
6.3. Manufacturing and Maintenance justification file.....	14
7. Exported constraints.....	15
7.1. Design and manufacturing by ALSTOM.....	15
7.2. Exported constraints for suppliers.....	15
8. Executive summary.....	18
8.1. Process summary.....	18
8.2. Items to check.....	18
9. Appendices.....	19

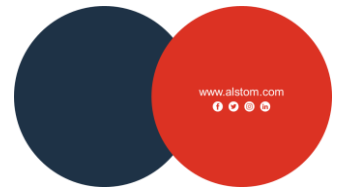

9.1.	Direct mounting references.....	19
9.2.	Example of “positive support” equipment mounting	19
9.3.	Example of anti-fall system.....	20



1. PURPOSE

This ALSTOM Standard defines the rules for assigning criticality to parts or assemblies (welded, riveted, glued or bolted) of rolling stock material and how it is transmitted by Design Office to other entities with design deliverables.

Criticality of characteristics can be obtained by FMEA_Product approach. For generic use cases, this standard proposes a common way of working and criteria in order to have better quality in design, unique criticality evaluation and speed up the decisions. In some specific situations, deviation is possible with justification and acceptance by responsible entities (RAMS team in case of Safety).

Design activities define all the characteristics (dimensional, geometric, physical, functional, appearance, etc.) of parts and assemblies.

The consequence of non-compliance with one or more of these characteristics may vary; it can range from visual discomfort (non-compliance with colour tints) to equipment loss (break of an assembly or component). The potential consequences of non-compliance with design parameter have been classified into 3 categories, as described in the table below.

Category	Description	Examples of feared events
Safety (S)	This category includes consequences that may harm the physical integrity of individuals	Fall of parts, electrocution, gauge infringement, etc.
Regulation (R)	This category includes the non-respect of a normative requirement that cannot be negotiated with the final customer, excepted the previous S category	Failure to respect the height of vehicle thresholds versus platform (governed by the PMR decree)
Functional (F)	This category includes non-compliances with a functional requirement, excepted the previous S and R categories	Non-mountability, malfunction, non-maintainability of part, malfunction of an opening, loss of water tightness, presence of vibration, aesthetics, etc.

Table 1: Feared events classification

In this version of ALSTOM standard, the safety levels are derived from the analysis of:

- Potential hazard: Fall of parts for derailment and human injury (projectile).
- Potential hazard: Collision
- Category Safety (S)



2. NORMATIVE REFERENCES

2.1. STANDARD REFERENCES

Reference	Title
EN 15085-3	Railway applications - Welding of railway vehicles and components - Part 3: Design requirements
EN 17460	Railway applications - Adhesive bonding of rail vehicles and their components

2.2. ALSTOM STANDARD REFERENCES

Reference	Title
RSA-RS-WMS-002	SRIL Instruction (Safety Related Item List)
DTRF 150202	Extruded Aluminium Alloy Profile for Structural Applications
DTRF 150203	Aluminium Alloy Structure Cast Parts
DTRF 150204	Structural Steel Castings
DTRF 150207	Forged Structural Aluminium Components
DTRF 150208	Steel Forged Structural Parts
DTRF 150210	Fastened Assemblies Design
DTRF 150211	Design, Calculation & Validation Requirements for Welded Joints
DTRF 150214	Requirements for Fastened Assemblies Mounting
DTRF 150218	Riveted Assemblies or Lock Bolt Design
DTRF 150219	Riveted Assemblies or Lock Bolt Mounting requirements
DTRF 150221	Main Welding Terms
DTRF 150223	Design of Glued Assemblies
DTRF 150232	Fitting and Semi-Structural Composite Parts
DTRF 150237	Structural Iron Castings
DTRF 150260	Industrialization of Glued Assemblies
DTRF 150264	Purchasing Conditions of Adhesive Products



3. TERMS AND DEFINITION

3.1. SAFETY LEVEL

Safety level H, M and L is based on recognized standards EN15085-3 (welding) and EN17460 (bonding).

Safety Level	ALSTOM Definitions
H (High)	Failure of the assembly leads to consequential events with personal injuries and breakdown of the overall function
M (Medium)	Failure of the assembly affects the overall function or can lead to consequential events with personal injuries
L (Low)	Failure of the assembly does not directly affect the overall function. Consequential events with personal injuries are unlikely
Z (used only for Bonding assemblies)	Failure of the adhesively bonded joint does not lead to any failure of the overall function and does not lead to personal injuries at normal operational conditions (e.g. leads solely to comfort losses).

Table 2: Safety level definition

3.2. SRIL

SRIL is defined by RSA-RS-WMS-002 instruction. Only items categorized H level are part of SRIL on a mandatory basis and will be identified by a safety logo. Items declassified during STEP 5 (cf §4) are also recorded in the SRIL for traceability purpose.

3.3. SAFETY LOGO

The objective of the safety logo is to precisely identify/trace the safety related items and associated requirements to highlight the precise step/operation (analysis, step in assembly instruction, quality control, test control, maintenance control, etc) and to make aware the step/operation corresponding owner that it is safety related.

High safety level is the only one associated with safety logo  on design deliverables.

3.4. REDUNDANCY AND FALL ARRESTER

A redundancy system (or backup system) is able to fulfil all mechanical requirements as the initial system (same resistance, same load cases,...).

Redundancy system must be independent from initial fixation system, i.e. double the number of same fasteners is not considered as a redundancy due to common failure mode.

Fall arrester (retention device) is a system preventing equipment fall. Aim is to prevent equipment loss if initial fixation system breaks under regular conditions.

Design parameters to dimension fall arrester are listed in DTRF 150210 for bolted assemblies and DTRF 150218 for riveted assemblies.

3.5. STACKED ASSEMBLIES

For stacked assemblies (e.g.: equipment mounted on a frame, itself mounted on the car body shell), the analysis must be carried out at each "stage", depending on the mass likely to come off.

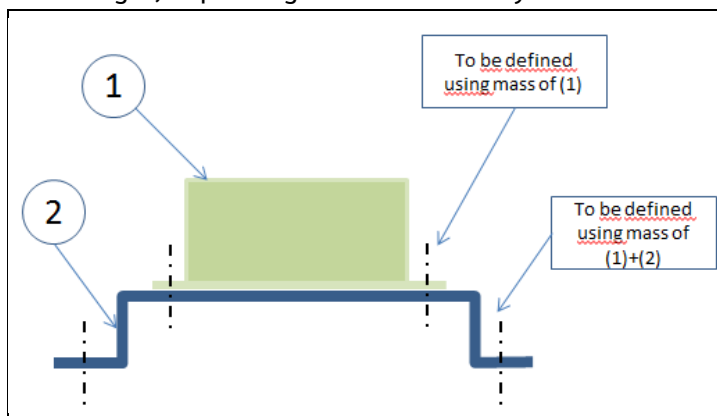

Figure 1: Case of stacked assemblies

4. PROCESS OVERVIEW

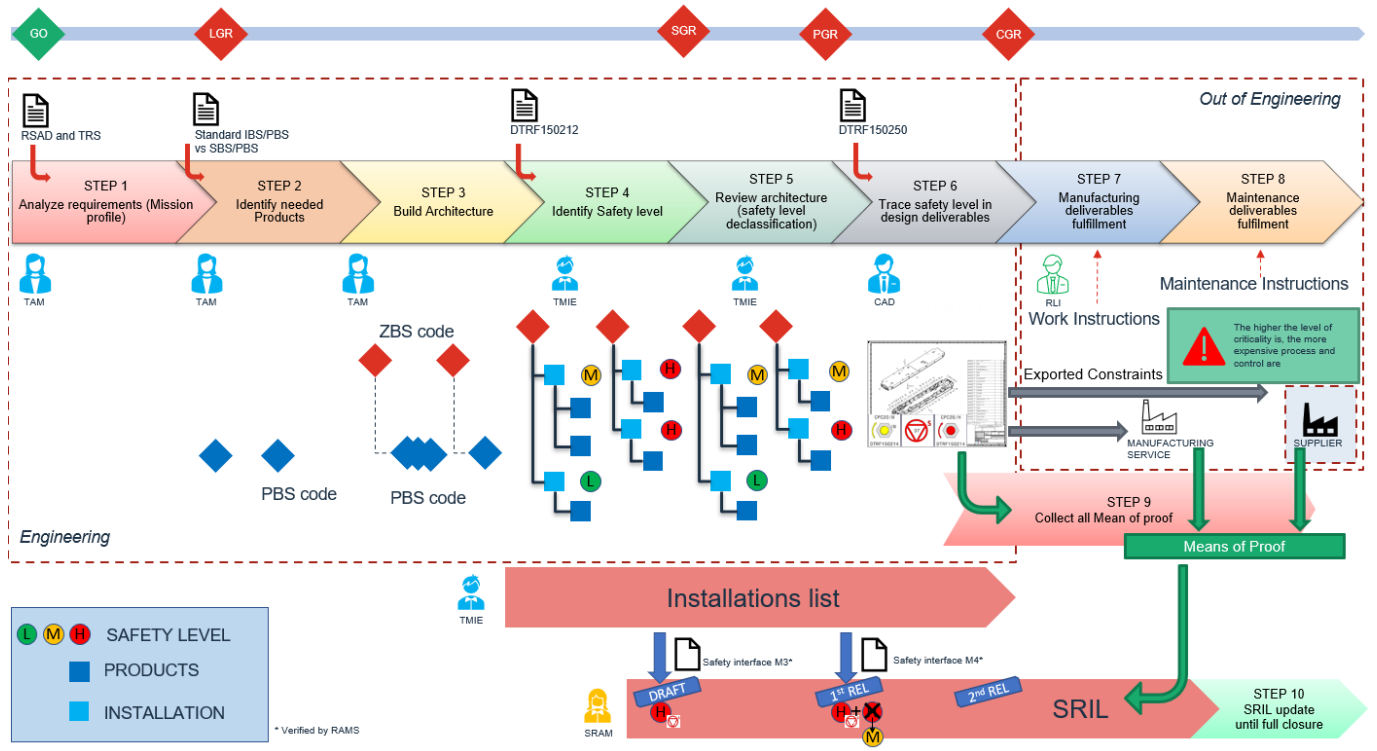

Figure 2: Process overview

Different steps are needed to define architecture and safety levels.

Safety levels (/H, /M or /L) (STEP 4) and mandatory design concepts are defined by decision tree in POST_150212. It has been built assuming that all ALSTOM rules (Engineering Instructions, Design Manufacturing & Control DTRF) are strictly applied.

Possibilities to declassify safety level (STEP 5) are proposed with several criteria:

- Second effort path
 - Full or partial fixations redundance with different fasteners
 - Anti-fall system by design (sling / positive mounting)
 - Anti-fall system by consideration such as cables, piping, earthing braid
- Specific environment
 - U-Shape preventing fall (lateral), other equipments
 - Inside structural frame (electrical cubicle)
 - Above closing sheet (electrical cubicle) or above lining / ceiling

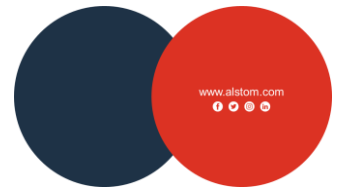

- Detection or return of experience
 - Continuous check with accessibility in commercial service
 - High quantity of same fastener or weld (example: 60 loose rivets) is considered as fall arrester or redundancy by positive return of experience (same technology, same conditions, same detection ability during assembly).

Remind: Small quantity of same fastener or weld (example: 6 loose bolts) is not considered as fall arrester or redundancy because it does not avoid the common mode even if the assembly is over dimensioned.

For all fall arresters, the only feared event taken into account to declassify the safety level is fall of parts. If one of the above proposals could impact gauge infringement or risk of electrocution, for example, safety level must not be reduced.

Decision flowchart allows also to select/reject design principles. If mounting principles don't respect them, a justification must be specifically done by Engineering and accepted by RAMS team.

Process roles and responsibilities are defined in Table below:

Phase	Task	TD (Engineering)	RAMS (Engineering)	Industrialization	Quality	Procurement	Service
STEP 1	Analyze requirements (Mission profile)	A	C				
STEP 2	Identify needed Products	A					
STEP 3	Build Architecture	A	C	I			
STEP 4	Identify Safety level (before declassification)	A	C	C			
	Draft SRIL is created	I	A	I			
STEP 5	Review architecture (safety level declassification with arguments to be provided to RAMS)	R	A	C	C	C	C
	Mounting review for non flowchart cases or other feared events	R	A	C	C	C	C
	SRIL is released including justifications for H declassified in M	C	A	C	I	I	I
STEP 6	Trace safety level in design deliverables	A	C	C	I	I	I
STEP 7	Manufacturing deliverables fulfillment	I	C	A	C		I
STEP 8	Maintenance deliverables fulfillment	I	C	I	I		A
STEP 9	Collection of Design Mean of Proof	A	C		I		
	Collection of Manufacturing Mean of Proof		C	A	R		
	Collection of Supplier Mean of Proof	C (+ expert validation if needed)	C		R	A	
	Collection of Maintenance Mean of Proof		C		I		A
STEP 10	SRIL update until full closure	C	A	C	C	C	C

Table 3: RACI

R: Responsible
A: Accountable
C: Consulted
I: Informed



5. DESIGN CONCEPTS AND SAFETY LEVELS IDENTIFICATION FOR FALL OF PARTS OR COLLISION HAZARDS

A difference is made between main car body shell frames and structural assemblies (chap. 5.1), cubicle frames (chap 5.2) and fixed equipment bracket (chap 5.3).

POST_150212 fixes design concept and illustrates all different cases.

5.1. CAR BODY SHELL

Attention: This chapter does not concern equipment supports fixed on car body shell (welded or not), see chapter 5.3.

For sub-assemblies (underframe, sidewall frame, roof frame, end wall, cabin frame, bolster...), it is assumed here that they have been assembled by several welding connections (continuous or discontinuous), that ensures good sub-assembly integrity in case some links fail. Appendix G of EN15085-3 refers to alternative load path.

Therefore, car body shell sub-assemblies safety level is considered as “Medium Level”.

Considering connections of sub-assemblies to each other:

- Assembly by welding (continuous or discontinuous) is classified “Medium Level” for same reason than above
- Assembly by bolting or riveting is classified as “High Level” due to common failure mode.

5.2. ELECTRICAL CUBICLE FRAME

As for car body shell, the cubicle frame assembled by welding, bolting or riveting has a good integrity by multiplication of joints in several directions that represent alternative load paths. In addition, Electrical cubicle frames are not subject to force transmission.

Therefore, Safety Level is considered as “Medium Level”.



5.3. EQUIPMENT

Safety level and design concept are defined for equipment fixed on car body shell or mounted into or on cubicle frame considering:

- Transmission effort
- Zone and location of equipment
- Height
- Weight
- Train Speed

Design concept shown in the decision tree for each of the cases are mandatory to be respected with their dedicated safety level:

- In case of direct mounting, HRC bolts or lockbolts (BOBTAIL) are mandatory. These bolts guarantee a minimum preload (poka yoke)
- Good combination of direct and positive mounting in case of dismounting need

In addition:

- For rotating machines whose mass is more than 20% of the total weight of the equipment, dedicated anti fall system is mandatory (higher risk due to unbalance)
- Tapping is prohibited for permanent connection to the side sill

Even if decoupling does not change safety level of components and assemblies by itself, it must be considered in the assembly evaluation and must be classified accordingly. Presence of decoupling is driven by:

- Frequency decoupling
 - Rotating/vibrating machines when not yet decoupled
 - Not transmitting vibrations to equipment
 - Moving car body shell eigenfrequency
- Deformation filtering
 - Not transmitting car body shell deformation to equipment

As for decoupling, shimming must be considered in the assembly and its safety evaluation. Need of shimming is mainly caused by:

- Wheel wear compensation

5.4. CABLING AND PIPING

Due to the multiple fixations and clamping, cabling and piping parts and assemblies are classified as “Low level” safety level.

6. PROJECT DELIVERABLES

6.1. DESIGN DELIVERABLES

Technical documentation contains safety levels and the safety logo for H level. Few examples in below tables.

2D Example	3D FTA Example

Table 4: Example of identification of safety levels and « Safety » logo (bolted assembly)

<p>DTRF150215 CP C2 CL 1</p> <p>CONFIDENTIAL INFORMATION: The reproduction, distribution and utilization of this document as well as the communication of its contents to others without express authorization is prohibited. Offenders will be held liable for the payment of damages. All rights reserved in the event of the grant of a patent, utility model or design.</p> <table border="1"> <thead> <tr> <th colspan="2">IE-300</th> <th colspan="2">EN ISO 13920-BBE</th> </tr> <tr> <th colspan="4">--- -- --</th> </tr> <tr> <th colspan="4">NEW CREATION/VERSION</th> </tr> </thead> <tbody> <tr> <td>A 0</td> <td></td> <td></td> <td></td> </tr> <tr> <td>B 0</td> <td>CR0004157/CR0003956/</td> <td>Drawn</td> <td>Tech D 2017-10-23</td> </tr> <tr> <td>C 0</td> <td>CR0005239/CR0005341/</td> <td>Checked</td> <td>VE 2017-11-07</td> </tr> <tr> <td>D 0</td> <td>CR0006411</td> <td>Approved</td> <td>VE 2017-11-07</td> </tr> <tr> <td>E 0</td> <td>CR0006679/CR0006628/CR0010562</td> <td></td> <td></td> </tr> <tr> <td>F 0</td> <td>CR0011770</td> <td></td> <td></td> </tr> <tr> <td>Index</td> <td>Rev. Actif. No.</td> <td></td> <td></td> </tr> </tbody> </table>	IE-300		EN ISO 13920-BBE		--- -- --				NEW CREATION/VERSION				A 0				B 0	CR0004157/CR0003956/	Drawn	Tech D 2017-10-23	C 0	CR0005239/CR0005341/	Checked	VE 2017-11-07	D 0	CR0006411	Approved	VE 2017-11-07	E 0	CR0006679/CR0006628/CR0010562			F 0	CR0011770			Index	Rev. Actif. No.			<p>DTRF150215 CP C1 CL 1</p> <p>CONFIDENTIAL INFORMATION: The reproduction, distribution and utilization of this document as well as the communication of its contents to others without express authorization is prohibited. Offenders will be held liable for the payment of damages. All rights reserved in the event of the grant of a patent, utility model or design.</p> <table border="1"> <thead> <tr> <th colspan="2">IE-300</th> <th colspan="2">EN ISO 13920-BBE</th> </tr> <tr> <th colspan="4">--- -- --</th> </tr> <tr> <th colspan="4">NEW CREATION/VERSION</th> </tr> </thead> <tbody> <tr> <td>A 0</td> <td></td> <td></td> <td></td> </tr> <tr> <td>B 0</td> <td>CR0004157/CR0003956/</td> <td>Drawn</td> <td>Tech D 2017-10-23</td> </tr> <tr> <td>C 0</td> <td>CR0005239/CR0005341/</td> <td>Checked</td> <td>VE 2017-11-07</td> </tr> <tr> <td>D 0</td> <td>CR0006411</td> <td>Approved</td> <td>VE 2017-11-07</td> </tr> <tr> <td>E 0</td> <td>CR0006679/CR0006628/CR0010562</td> <td></td> <td></td> </tr> <tr> <td>F 0</td> <td>CR0011770</td> <td></td> <td></td> </tr> <tr> <td>Index</td> <td>Rev. Actif. No.</td> <td></td> <td></td> </tr> </tbody> </table>	IE-300		EN ISO 13920-BBE		--- -- --				NEW CREATION/VERSION				A 0				B 0	CR0004157/CR0003956/	Drawn	Tech D 2017-10-23	C 0	CR0005239/CR0005341/	Checked	VE 2017-11-07	D 0	CR0006411	Approved	VE 2017-11-07	E 0	CR0006679/CR0006628/CR0010562			F 0	CR0011770			Index	Rev. Actif. No.		
IE-300		EN ISO 13920-BBE																																																																															
--- -- --																																																																																	
NEW CREATION/VERSION																																																																																	
A 0																																																																																	
B 0	CR0004157/CR0003956/	Drawn	Tech D 2017-10-23																																																																														
C 0	CR0005239/CR0005341/	Checked	VE 2017-11-07																																																																														
D 0	CR0006411	Approved	VE 2017-11-07																																																																														
E 0	CR0006679/CR0006628/CR0010562																																																																																
F 0	CR0011770																																																																																
Index	Rev. Actif. No.																																																																																
IE-300		EN ISO 13920-BBE																																																																															
--- -- --																																																																																	
NEW CREATION/VERSION																																																																																	
A 0																																																																																	
B 0	CR0004157/CR0003956/	Drawn	Tech D 2017-10-23																																																																														
C 0	CR0005239/CR0005341/	Checked	VE 2017-11-07																																																																														
D 0	CR0006411	Approved	VE 2017-11-07																																																																														
E 0	CR0006679/CR0006628/CR0010562																																																																																
F 0	CR0011770																																																																																
Index	Rev. Actif. No.																																																																																

Table 5: Examples of identification of safety levels and « Safety » logo (welded assembly)

In case of several assemblies and “safety” logo, design deliverable must be organized with below rules:

- Position “safety” symbol near the title block. A text indicating the total quantity of safety items is centered on the safety symbol.

Position “safety” symbol near each different type of item with a text indicating the quantity of identical items and a leader heading on one of these items (if no possible confusion) or as much leaders as items (if confusion is possible).

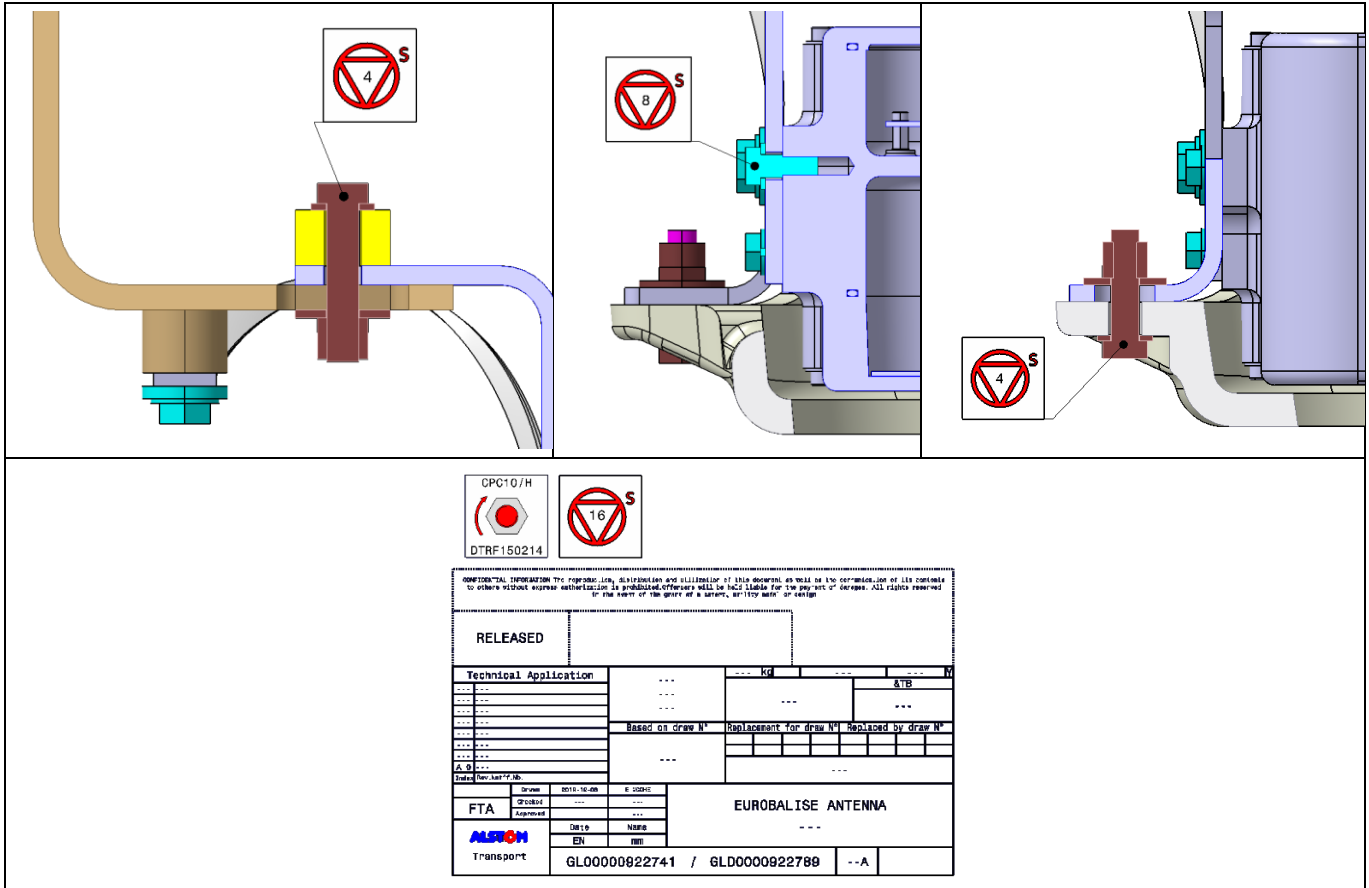

Table 6: Example of several “safety symbols”

6.2. ENGINEERING JUSTIFICATION FILE

The justification file gathers calculation notes, procedures and test reports or any document used to demonstrate compliance with applicable EI and DTRF for safety level H parts and assemblies.

These documents must have the “Safety” logo on the cover page.

6.3. MANUFACTURING AND MAINTENANCE JUSTIFICATION FILE

The justification file gathers any document used to demonstrate compliance with applicable H parts and assemblies requirements:

- Manufacturing: documents requested by applicable DTRF to special processes and control plan
- Maintenance: maintenance plan



7. EXPORTED CONSTRAINTS

7.1. DESIGN AND MANUFACTURING BY ALSTOM

For each type of assembly and depending on safety level (indicated on deliverables), the specific requirements applying from design to manufacturing and quality control are described in the following ALSTOM standards:

Assembly principle	Manufacturing and control
Welding	DTRF 150221
Bolting	DTRF 150214
Riveting	DTRF 150219
Bonding	DTRF 150620

Table 7: Applicable documents for assemblies

For each type of manufactured parts and relatively to safety level, critical characteristics must be declared on drawings with following standards associated if needed:

Part Type	Manufacturing and control
Sheet metal parts	DTRF 150249

Table 8: Applicable standards for parts

7.2. EXPORTED CONSTRAINTS FOR SUPPLIERS

3 cases are considered:

- Case 1 - Supplier in charge of complete design and manufacturing of product and assembly
- Case 2 - Supplier in charge of complete design and manufacturing of product
- Case 3 - Supplier in charge of manufacturing of product

Note 1:

- For cases 1 and 2, it is not the responsibility of ALSTOM to define the rules to be applied. If we are forced to proceed in such a way it means the case 3 must apply. There is no in between approach
- Selection of the supplier shall follow the ALSTOM rules and is documented by Quality.

Case	ALSTOM MUST EXPORT	SUPPLIER MUST, for acceptance purpose																												
Case 1 - Supplier in charge of complete design and manufacturing of product and assembly	<ul style="list-style-type: none"> Performance requirements (including safety requirements regarding fall of parts and electrocution) Conditions usage (mission profile, speed, environment, ...) as well as exceptional events and related consequences 	<ul style="list-style-type: none"> Share technical solution with ALSTOM based on technical drawings, calculation note, safety analysis and compliance with safety requirements. Especially, absence or presence of redundancy mechanisms must be justified and demonstrated 																												
Case 2 - Supplier in charge of complete design and manufacturing of product	<ul style="list-style-type: none"> Case 1 + Critical interfaces characteristics (geometry, stiffness, thickness, material) Presence of any redundancy in assembly if decided through TPS and interfaces drawing 	<ul style="list-style-type: none"> Explain how its internal processes prevents failure inducing a hazardous situation that may occur due to mistake at specification, design, manufacturing or installation phase Export constraints to ALSTOM (manufacturing and controls) including the safety related ones if any Share detailed interfaces design 																												
Case 3 - Supplier in charge of manufacturing of product designed by ALSTOM according to ALSTOM specifications	<p>Transmit all requirements through detailed drawings or specifications (TPS) including safety levels</p> <table border="1" data-bbox="524 695 1261 1094"> <thead> <tr> <th>Part Type</th> <th>Manufacturing and control</th> </tr> </thead> <tbody> <tr> <td>Aluminum profiles</td> <td>DTRF 150202</td> </tr> <tr> <td>Molded parts Al</td> <td>DTRF 150203</td> </tr> <tr> <td>Molded parts steel</td> <td>DTRF 150204</td> </tr> <tr> <td>Forged parts Al</td> <td>DTRF 150207</td> </tr> <tr> <td>Forged parts steel</td> <td>DTRF 150208</td> </tr> <tr> <td>Cast iron parts</td> <td>DTRF 150237</td> </tr> <tr> <td>Sheet metal parts</td> <td>DTRF 150249</td> </tr> <tr> <td>Composite parts</td> <td>DTRF 150232</td> </tr> </tbody> </table> <table border="1" data-bbox="524 1134 1261 1396"> <thead> <tr> <th>Assembly Type</th> <th>Manufacturing and control</th> </tr> </thead> <tbody> <tr> <td>Welding</td> <td>DTRF 150221</td> </tr> <tr> <td>Bolting</td> <td>DTRF 150214</td> </tr> <tr> <td>Riveting</td> <td>DTRF 150219</td> </tr> <tr> <td>Bonding</td> <td>DTRF 150620</td> </tr> </tbody> </table>	Part Type	Manufacturing and control	Aluminum profiles	DTRF 150202	Molded parts Al	DTRF 150203	Molded parts steel	DTRF 150204	Forged parts Al	DTRF 150207	Forged parts steel	DTRF 150208	Cast iron parts	DTRF 150237	Sheet metal parts	DTRF 150249	Composite parts	DTRF 150232	Assembly Type	Manufacturing and control	Welding	DTRF 150221	Bolting	DTRF 150214	Riveting	DTRF 150219	Bonding	DTRF 150620	<ul style="list-style-type: none"> Exhaustively perform Clause by Clause analysis for TPS, detailed drawings and ALSTOM Standard (DTRF) Demonstrate for all identified High safety level characteristics, through Process FMEA (with highest level of criticality), capability studies. Provide the evidence through process sequence and control plan (type & frequency).
Part Type	Manufacturing and control																													
Aluminum profiles	DTRF 150202																													
Molded parts Al	DTRF 150203																													
Molded parts steel	DTRF 150204																													
Forged parts Al	DTRF 150207																													
Forged parts steel	DTRF 150208																													
Cast iron parts	DTRF 150237																													
Sheet metal parts	DTRF 150249																													
Composite parts	DTRF 150232																													
Assembly Type	Manufacturing and control																													
Welding	DTRF 150221																													
Bolting	DTRF 150214																													
Riveting	DTRF 150219																													
Bonding	DTRF 150620																													

Table 9: Exported constraints

Note 2:

- Safety related characteristics exported by supplier in Case 1 are registered by Train Design department (interface & assembly). Then RAMS department manages the integration in the SRIL
- The supplier justification file is accepted by ALSTOM engineering (supplier design is challenged using as reference ALSTOM rules) and the safety demonstration file is accepted by RAMS department



8. EXECUTIVE SUMMARY

8.1. PROCESS SUMMARY

This document proposes a top-down approach to define safety levels, based on technical parameters related to the feared events
The identification of safety levels is done according to POST_150212 decision tree. Possibility to declassify safety level with several criteria is also defined
Design documents shall carry the safety levels for assemblies and parts
The justification file includes all technical documents with "safety" logo for safety level H parts and assemblies
Constraints are exported to all parties and suppliers

Table 10: What to remember

8.2. ITEMS TO CHECK

All assemblies must be marked with a reference to safety level (/H, /M or /L).
A "Safety" logo shall be affixed to the design documents in proximity to the critical assembly characteristics for H level only.
A "Safety" logo must be affixed to cover page of technical documents (or title block in case of drawings)

Table 11: Items to check

9. APPENDICES

9.1. DIRECT MOUNTING REFERENCES

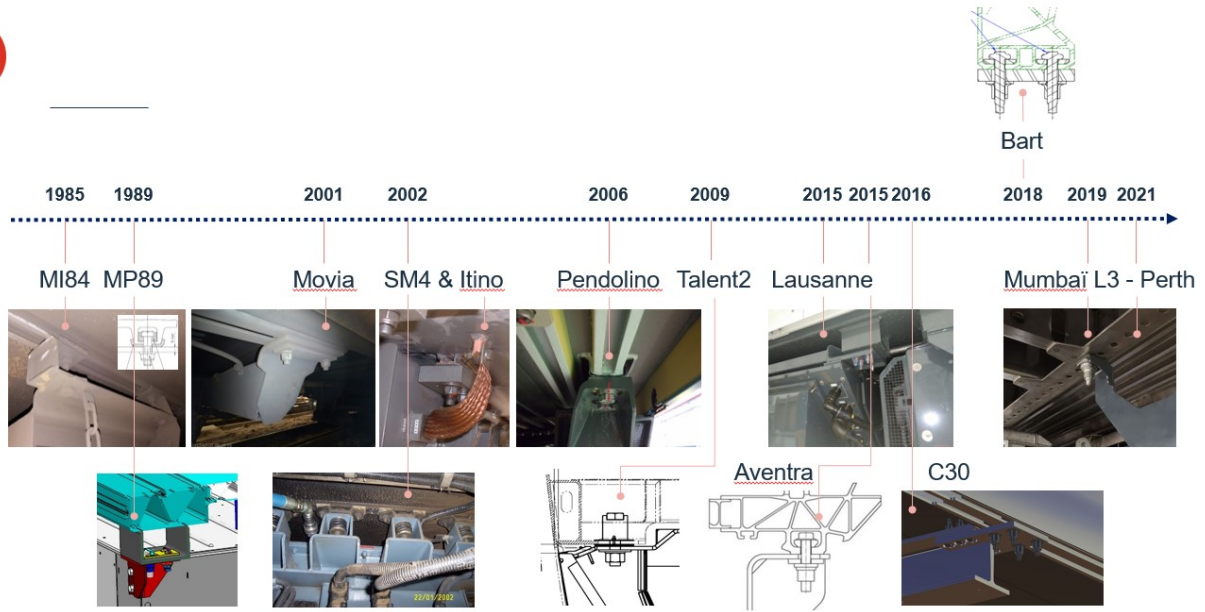

Figure 3 : Examples of direct equipment mounting:

9.2. EXAMPLE OF “POSITIVE SUPPORT” EQUIPMENT MOUNTING



Figure 4: « Positive » equipment mounting on metro platform

9.3. EXAMPLE OF ANTI-FALL SYSTEM

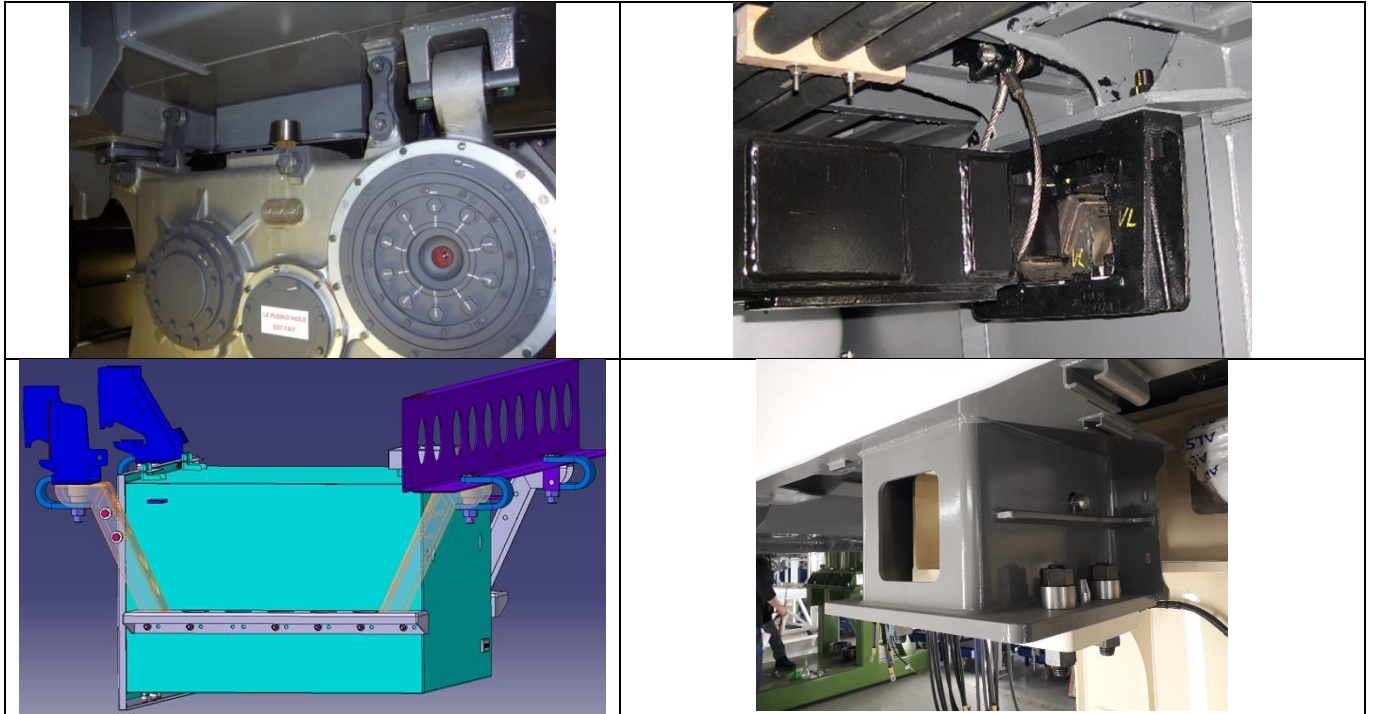

Figure 5: Anti fall systems